

SIŁY PRZEKROJOWE W BELKACH PROSTYCH - ZADANIE DOMOWE NR 2

Zadanie

Dla podanych belek wykonaj wykresy sił przekrojowych.

②

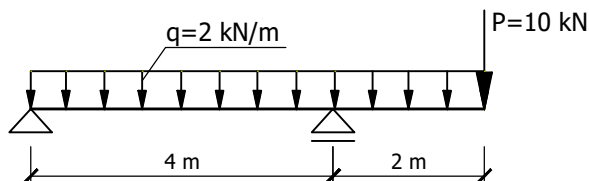

odpowiedź:

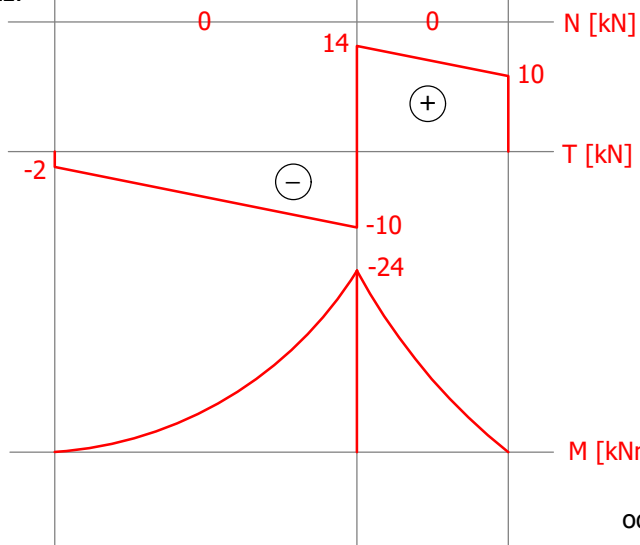

①

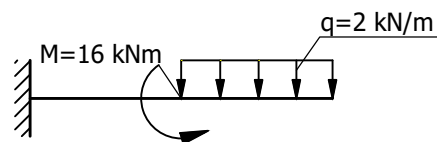

odpowiedź:

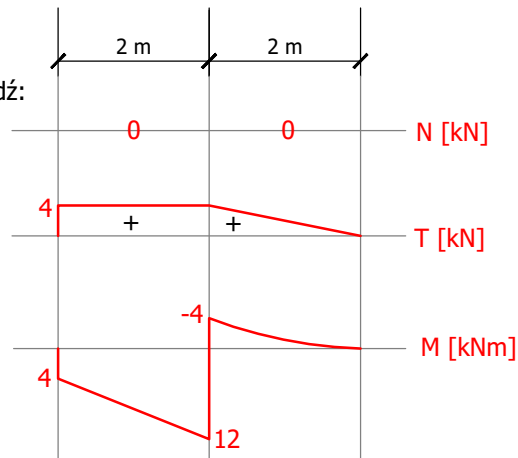

④

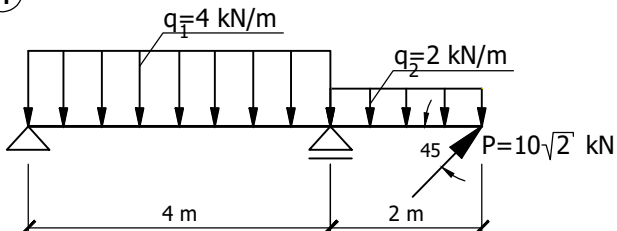

odpowiedź:

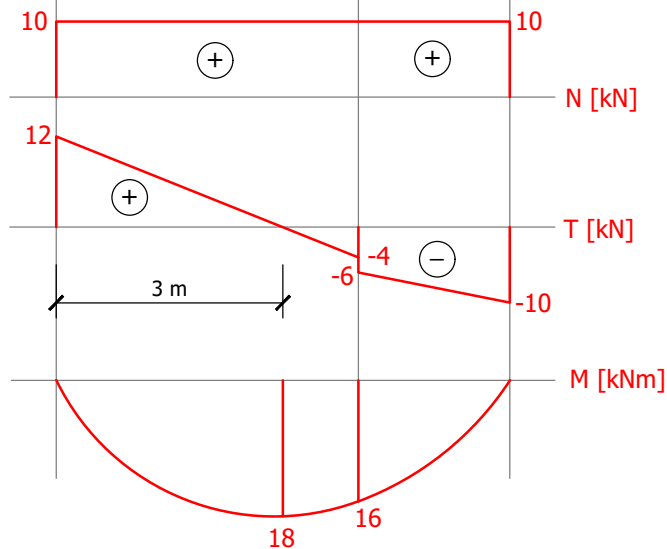

③

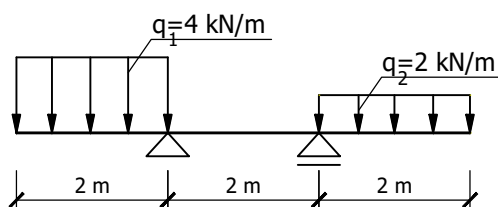

odpowiedź:

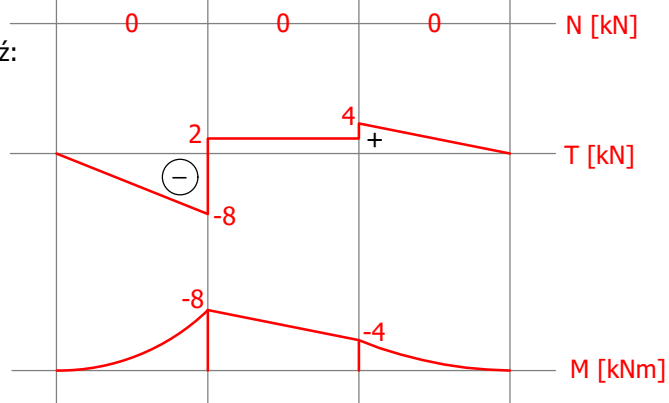

⑤

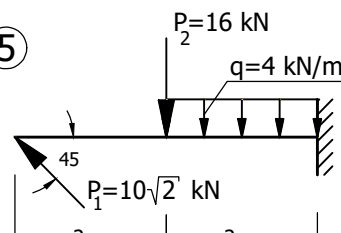

odpowiedź:

